



FP6YPT-B

Portrait touring yoke for FlexPoint FP6

Features

- Portrait orientation touring yoke
- Stand mount when used with pole mount adaptor ASF20045 (available separately)
- Truss mount when used with a third-party half-coupler
- Quick deployment with no tools required.
- Central hole: 12.5 mm (0.49 in); two inner holes: 6.2 mm (0.24 in); two outer holes: 8.2 mm (0.32 in)
- Available in black

Applications

- Touring flown FlexPoint FP6
- Touring pole mounted FlexPoint FP6

Contents

- 1 x FP6YPT-B yoke

Technical Specifications

Weight: 1.49 kg 3.29 lb

Material: Weatherised polyester powder coated steel

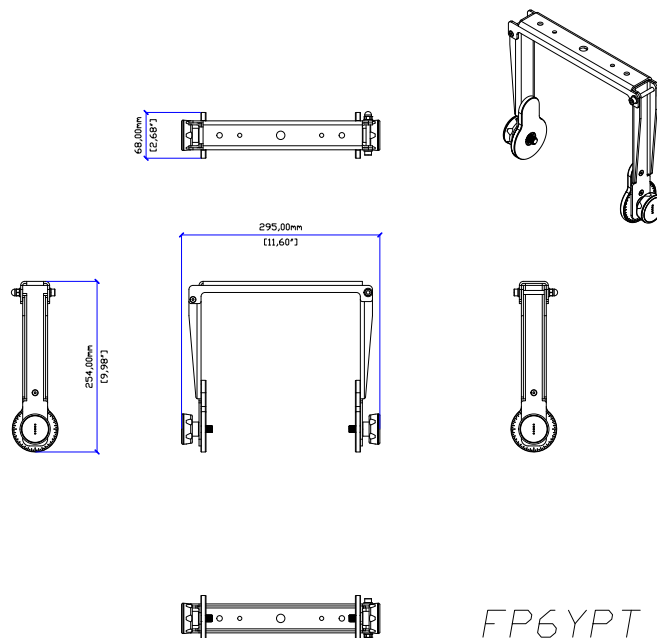

FP6YPT